

※ 尺寸/Dimensions 单位/Unit : (mm)

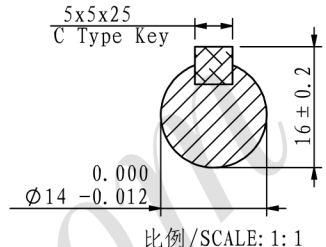

※ 刹车/Brake

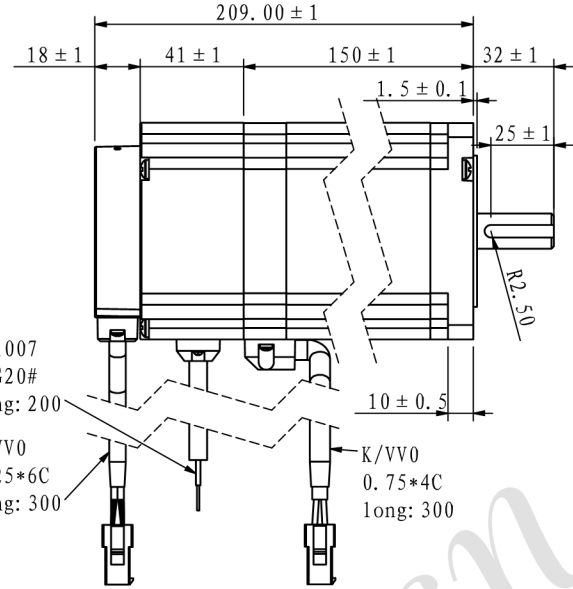
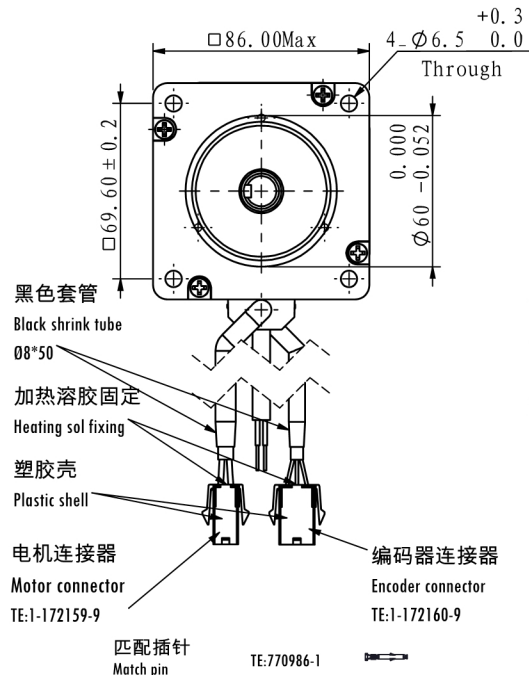
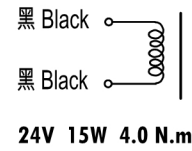

※ 编码器(1000CPR)  
Encode control(1000CPR)

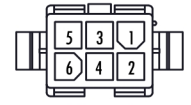

1	红/Red	+5V
2	黑/Black	EGND
3	白/White	PB+
4	白黑/White&Black	PB-
5	绿/Green	PA+
6	绿黑/Green&Black	PA-

※ 电机规格/Motor Specification

相数/No. of phase	2 相/phase
步距角/Basic step angle	1.8°
步距角误差(空载)Positional accuracy(no-load)	±0.09° 以下/Max
额定电流/Rated current	6.0 A
保持扭矩/Holding torque	12.5 N.m
相电阻/Phase resistance	0.75 ± 10% ohm(20°C)
相电感/Phase inductance	8.2 ± 20% mH(1KHz)
转子惯量/Rotor inertia	≈ 4000 g.cm <sup>2</sup>
重量/Weight	≈ 6.5 Kg
绝缘耐压/Dielectric strength	500V A.C
绝缘电阻/Insulation resistance	100MΩ 以上/MIN
绝缘等级/Insulation class	B
使用温度范围/Operation ambient temperature	0°C ~ +50°C
使用湿度范围/Operation ambient humidity	20%RH ~ 90%RH
使用温度范围/Storage ambient temperature	-20°C ~ +70°C
保存湿度范围/Storage ambient humidity	15%RH ~ 95%RH

※ 接线图/Wiring diagram

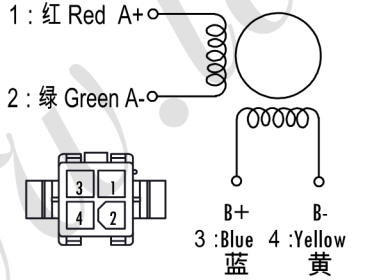

※ 励磁顺序 (2相励磁)

Phase sequence(2 phase exciting)

Step	A	A-	B	B-
1	+	+	-	-
2	-	+	+	-
3	-	-	+	+
4	+	-	-	+
5	+	+	-	-

CW (down arrow), CCW (up arrow)

※ 铭牌内容

Label discription

名称/Name	两相步进电机	型号/Model	LS86E125-K4J60S04-BL
品号/Product No.		客户型号	
客户品号		客户品号	

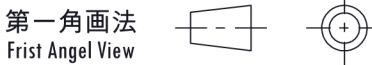

版本/Rev	日期/Date	变更内容/Revision record
制图/Drawn	2019/12/3	设计/Design
审核/Checked	2019/12/3	批准/Approved

名称/Name: 两相步进电机 2 phase stepping motor

公差 Tolerance: ±0.3, 比例 Scale: 1:3, 页码 Sheet: 1/1

客户型号 Customer model:   
 客户品号 Customer Product No.:

**LEESN** 深圳市立三机电有限公司  
Shenzhen Lisan Machinery & Electric Co., Ltd